

Grand Shelters

ICE BOX

Instruction Manual

Warning: Use caution when knocking an igloo down. Falling igloos can cause serious injuries.

Grand Shelters Inc.

1327 Sherman Drive
Longmont, Co 80501, USA

303-772-2107

Toll free US and Canada

866-772-2107

Email: iglooinfo@grandshelters.com

Reprinted 2012

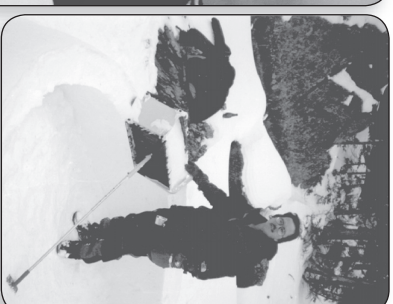

What is the ICEBOX?

The ICEBOX was invented by experienced winter mountaineers, who have built and camped in a variety of snow shelters in Colorado's mountainous backcountry.

For many years, they have used the basic concept of a concrete form to construct the walls of rock-roofed snow caves.

Transferring the idea to igloo construction, they developed the igloo slip form that became the ICEBOX.

Unlike digging a standard snow cave, you will remain relatively dry as you build your igloo. The ICEBOX has been designed to produce a dome-shaped igloo every time. The flying buttresses of European

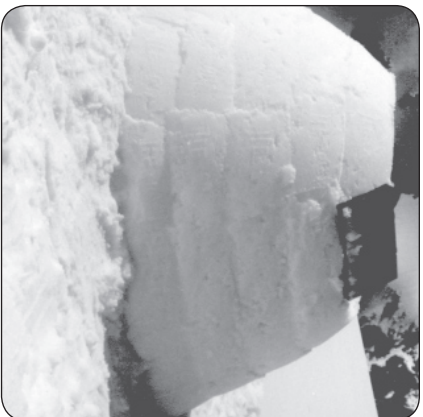

cathedrals are constructed on this same principle — it is self-supporting in that the pressure pushing in is equalized by the pressure pushing down. It will not collapse or bulge outward as will a hemispheric-shaped igloo. While a standard snow cave will rarely last more than a weekend, you can expect to use your ICEBOX igloo in reasonable safety for most of the season.

“You can't even make a snow ball with this snow.”

For the last 10 years or so we have paid attention and tried to figure out what underlying theory or technique fit the formula for packing all types of snow. What we have come up with is a description of a packing technique that works in all conditions.

Try this test: Squeeze some snow by holding your hands in the “prayer” position. Squeezing gently, hold that pressure for four seconds and release evenly. The amount of pressure needed is very little and you will feel it build up in your hands. At some point, the snow will “lock up” and stop moving. This is where you want to stop increasing the pressure.

Now apply more pressure. You will feel the snow move and “lock up” again. If you hold at this point for four seconds and release evenly you will have a chunk of snow in your hands. You can continue to increase the pressure and feel these steps of “locking up” at various different pressures. Not being able to release evenly is the problem with the higher pressures. With all the years of packing snow and now using the ICEBOX for eight years, we have come to recognize the pressures required when packing. For another experiment, push on a bathroom scale with your flat hand. You should approximate six to seven pounds of pressure when packing. More than this and you run the risk of moving the ICEBOX form, therefore causing fractures in the block you are building. Practice and patience will help you perfect this technique.

Notes

Solo Build and 7 ft. Solo

It is possible for one person to build an ICEBOX igloo with some variations of the instructions. Follow same instructions for site preparation and snow gathering. Here are some additional notes to keep in mind.

First two layers

- The first two layers can be packed from the outside, stepping over the wall only to release the Toggle Handle and reposition the form. All courses are done from the outside for the 7 ft. igloo.

Subsequent layers

- Shovel snow into igloos larger than seven foot after the second course is completed and just before the third course is completed. One can step over the wall until just before the third course is finished. All igloos can be built from the outside through the third layer and the seven footer can be built entirely from the outside.
- The Outer Panel can be removed on the third course for the 7 ft. igloo, because the form is more tilted than on the larger igloos with more perpendicular walls. This enables the solo builder to pack the blocks and move the form from the outside. The Inner Panel is held on the top leading corner while the first shovel full of snow is put on and packed with the other hand. Once a little snow is put into the form and packed, it is not necessary to hold it, as the snow will hold the form in place. The Inner Panel should be at a bit of an angle so that when the form is slid ahead, without releasing the Toggle Handle, it will come loose. If you do not remove the Outer panel on the third layer, pile snow against the igloo where you can reach from the inside.

- The solo builder can lay on the 7 ft. igloo while building the last two courses making it very easy to reach and pack the blocks.
- For larger than 7 ft. solo builds: Before finishing the third layer, shovel a large amount of snow inside the igloo so you can fill the form from the inside and also move/reset the form. You will need to take care to prevent popping the socket pole and stake apart. The pile of snow in the inside does require some maintenance but it becomes obvious to the user and need not be dwelt upon, just note the interference problem.
- For larger than 7 ft. solo builds: Leave the outside panel on for the sixth layer as it is easy to get the snow in from the inside and it is a lot easier to pack as there is no one on the outside helping pack the lower part of the block.
- For larger than 7 ft. solo builds: As the hole gets smaller you will need a shovel that you can shorten the handle on. This will make it easier to maneuver. For the last few blocks the hole gets small enough that you may use only the blade or, the outside panel. Fill it with snow, lift it up and dump.
- A good pair of gloves are needed for solo building to keep your hands drier. Fill the form as full as possible before packing so you shovel less. The more your hands warm the shovel, the more the snow melts and refreezes which sticks to the shovel and wets your hands.

ICEBOX Parts List

Check to make sure your ICEBOX contains the following pieces. Upgrades or spare parts may be ordered from our web site (www.grandsheeters.com) or by phone or mail. Please refer to these part names when ordering. In addition to these parts, we recommend a backpacking shovel with a long reach.

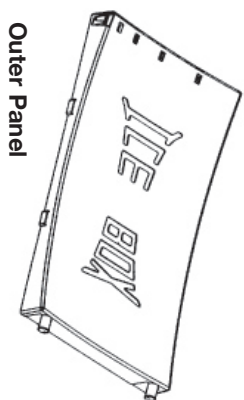

Outer Panel

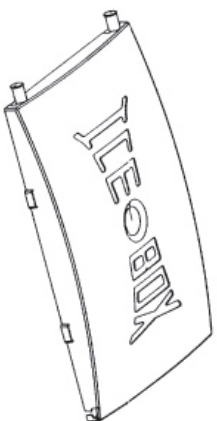

Inner Panel

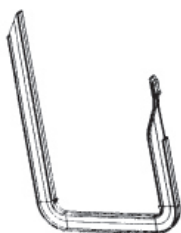

U Bar

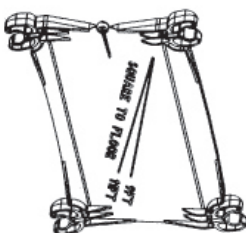

End Panel

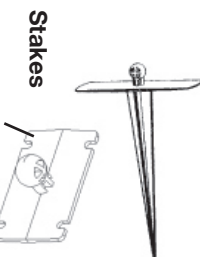

Stakes

For Shallow Snow
(Mount to plywood with wood screws)

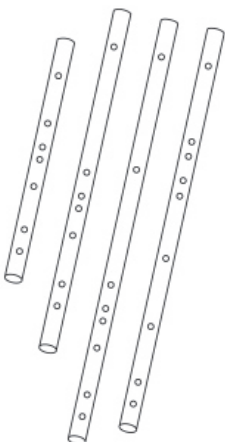

Large (Diameter) Poles



Small (Diameter) Pole

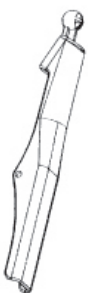

Toggle Handle



Toggle Link



Socket Pole



4 Retainer clip with straps and buckles
(Straps and buckles not shown)

Site Preparation

The ICEBOX requires at least two people for construction of an igloo. One person, referred to in this manual as the Form Handler, holds the ICEBOX in position while one or more Shovelers fill the form with snow.*

*Note:

Though we include instructions for a solo build in this manual, (see solo build on page 22) an inexperienced individual should not expect to be able to take the ICEBOX out into the backcountry and singlehandedly construct an adequate snow shelter.

We also recommend that first-time users practice igloo construction under noncrucial conditions at least once. Carefully following directions should result in a perfectly adequate igloo the first time but we prefer you to make any mistakes without jeopardizing your safety.

Preparing the Foundation

- An ideal site for your igloo is open ground with a minimum snow depth of two and a half to three feet before packing. This will help prevent damage to underlying vegetation. With skis and/or snowshoes, pack a level area three feet in diameter bigger than the igloo size you are building. Make sure your platform is level.
- We find it best if you make your floor on a flat area that has a small drop off along it, or a bit of a slope. If you do build on a flat area and you have steps going down into a trench, you will want to keep in mind that if you are in the wind, your trench will fill with snow and be difficult to dig out. A short level trench that comes out the side of a slope is much easier to remove snow from.
- For best results, try not to walk in the area where you will be gathering snow. Enter and leave the area by the same path to avoid compacting the surrounding snow. This will make shoveling easier when construction begins.
- Continue to pack the base by foot until it is solid and level. For sugar snow or depth hoar, you may need to let it set for 15 minutes or so. The Form Handler, who works within this circle, should be able to walk, stand or kneel on this surface without sinking in, stumbling or otherwise jarring the form. It's particularly important that you make the center of the base rigid so that the stake will not shift once you've planted it.
- If you have enough snow, you may want to pack down a platform 12-18 inches deep so that you can later cut out a trench. This way you can sit without being cross-legged and stand fully upright if desired. This platform should extend 10" from the outside edge of the igloo. Remember to maintain it while you are building, so it can be used to reach the top later on.



After completing the preloading on the corner, put in one shovel full of snow and pack it. If you push hard enough, you will feel a "lock up" happen when you have spread the panels about 1/16 to 1/8 inch. If you push too hard, the previous layer will give way and the block will be fractured.



From this point on you will want to build onto the previous block and the lower block. Come out of the corner at an angle up the previous block. The front of the form by the End Panel is the last area to be packed. When packing by the End Panel, hold the form on the left corner and push to the right a bit. The packing pressure used may make the form slide to the left. If the form does slide, it will create a little air gap below the snow you are packing and undermine the support for packing the upper layers. If this happens, the corner of your block will fall when you move the form. If you preload the form and continue the packing with the 1/16 to 1/8 spread with each shovel being packed, the form is tight enough to grip the part of the block that is already built. The texture on the inside of the form was designed for this purpose. It adds friction to prevent the form from sliding to the left when packing next to the End Panel.

As you get higher on the wall, you may notice that there are gaps that the snow can run out of. You will need to position the form to close these gaps. At this point, fill the form 1-1/2 inches below full, depending on the size of the igloo you are building and even with previous block. After filling the block, if it is packed right, you can move the form immediately.

Lift or pull up the U bar until it is loose and continue to hold onto it with your right hand. With your left hand lift the toggle handle slowly and don't let it pop. When you do this, the block may sag a little. Do not let the toggle pop loose. You can try bracing a knee against the pole, flexing it to make the pole shorter. After the form is loose and you are holding onto the U bar, use your left hand to hold onto the End Panel. Then slide the form off the block and set the entire form ahead of the block and on the wall. Set it at an angle so it won't fall onto or off the wall. (See Picture on page 11)

Once you set the form on the wall the U bar will drop back into the clamped position by itself. Then, after resetting the toggle, spread the form enough to slide it back onto the previous block.

Filling & Packing the ICEBOX Form — in Detail

Pull slightly on the top left corner of the form, top left for the Form Handler standing or kneeling inside the igloo, until the form is bowed and the pressure is transferred through the form and across the pole to the lower right corner of the form.

Pack the snow into the corner on the inside of the form with one push directly into the corner created by the form, the previous block and the floor or layer below. This push shouldn't break the other blocks, but should move the inside form about 1/8 or 1/4 inch towards the inside man. A couple more pushes and the snow is packed. It is important that subsequent pushes after the first don't move the form or fracture the snow.

The next shovel of snow should be placed in the corner created by the outside form panel and the two snow blocks previously mentioned. This is the critical snow to be packed because it adds support if done correctly. Push into the outside corner the same as you did on the inside corner, but hard enough to spread the form about 1/2 to 3/4 inch. Hold this pressure for a few seconds.

If upon releasing, the snow gives and the form comes back together, push again and have the Shoveler place another amount of snow on your hand and against the outside panel. It should hold when you release this. If it doesn't, repeat until it does.

This preloads pressure into the U bar and the entire form making the form more rigid. The pressure used to do this is greater than the pressure used to pack the rest of the block, possibly 10 to 15 pounds of pressure.

During this process, continue to hold the pressure on the top left corner of the form. After the lower right corner is complete and the form is preloaded with pressure, you can release the pressure on the top left corner. You will only need to hold a slight pressure after this to steady the form.



Note: The base size allows for the thickness of the walls plus a ledge surrounding the igloo. The ledge will prove extremely useful as the wall nears completion and the Shovelers have to reach above their heads.

- If the site is sloped, pack the down hill side first. One person should keep walking along the edge while the others move snow from the high side and throw it into the packers' footsteps. It also saves a lot of energy if you push the snow whenever possible.

- Once you have a level floor, pack the area where the center stake is going to be placed first. This will help it to set and be more stable. Stomp as deep as you can in the center and start packing your way up and out of the hole you have stomped. It is also best if you keep this in mind as you are leveling and building the floor. This gives the snow more time to setup and it will be stronger. Be very careful not to fracture this area when completing the floor and setting up the ICEBOX.

- Thinking ahead can save you problems later. Plan to have your door facing a shady area for most of the day. This will help that side of the igloo remain stable when you cut a door or entry tunnel, by slowing down any melting that may occur.

The ICEBOX is lightweight and easy to carry. Make sure the snap posts are at the top when transporting to prevent them from breaking should you slip and fall on something hard. This will also keep any spare parts from falling out.

Note the direction of the clips.

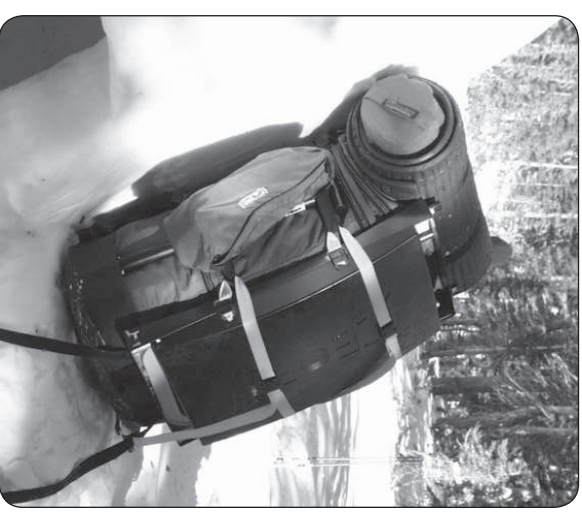

Assembling the ICEBOX

Familiarize yourself with the names of each part and how they are packed. When repacking the ICEBOX, put straps in first, and then the parts. (Next page)

- Place the (larger) **Outer Panel** of the slip form on a flat surface with the ribbed side facing down and the snap posts to your left. (See Diagram A-1)
- Snap the **End Panel** on to the posts. Make sure the edge marked "**bottom**" is toward you and the line labeled "**square to floor**" is facing out and to your left.

Tips

If there are gaps between the igloo form and walls, put your arm against the area. Gently fill gap with snow, applying a slight pressure.

- With the ribbed side facing up, snap the (smaller) **Inner Panel** onto the End Panel. (See Diagram A-1 below)

- Roll the assembly toward you so that the Outer Panel faces away from you and the End Panel is to your left.
- Note the slots on top of both sides panels at the corner of the open end of the form. Insert the U Bar into these slots so that the longer end slides smoothly into the Outer Panel. The cam on the U Bar will snap into the slot on the Inner Panel (See Diagram A-2 below)

- There are five pole segments with the ICEBOX kit — the larger diameter poles, marked **Igloo Size 8 or 9 ft., Igloo Size 11 ft., Igloo Size 10 ft., 7 ft. Igloo** and a smaller diameter pole with two spring clips. Find the large pole segment labeled with the size igloo you want to build. For the 7 ft., it is the shortest, large diameter pole. There is a spring clip at the end of this pole. Snap the plastic socket pole onto this spring clip.

- Snap the the socket pole onto the stake



Note U Bar is opposite posts when packing.

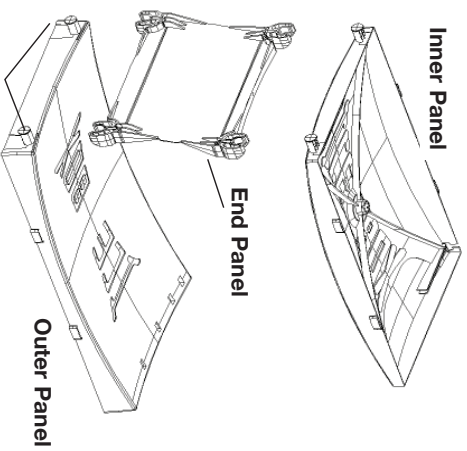

Diagram A-1

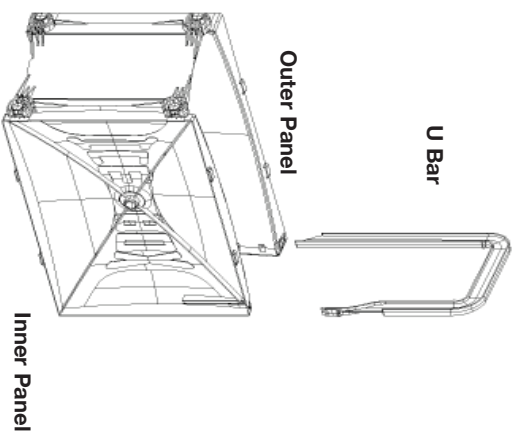

Diagram A-2



Ventilation

Some of our IceBox customers have asked about ventilation so we tested for carbon monoxide levels with the following conditions. Here are our findings.

For ventilation we had a 3 inch gap below a door which was a hanging poncho and a 1 inch diameter hole in the center of the ceiling.

With a lantern and stove burning and using ISO-butane fuel the CO level was below 5 ppm.

With a burning stove using Coleman fuel we had readings of 22 ppm 12 inches below the ceiling and 20 ppm 10 inches above the floor. The levels were well below the OSHA levels labeled as hazardous.

The Occupational Safety and Health Administration (OSHA) standard for exposure to carbon monoxide prohibits workers' exposure to more than 35 parts of the gas per million parts of air (ppm), averaged over an 8-hour workday. There is also a ceiling limit of 200 ppm (as measured over a 15-minute period).

Tips

- ✓ For either door treatment, you can use a tarp or poncho as a door covering. Fold in half and hang from the corners. Add snow into the pouch you've created for added weight to keep door sealed.
- ✓ When you are in windy conditions, we recommend keeping your door 6" above the ground to guard against snow drift. Also always keep your shovel with you when you are inside the igloo to guard against suffocation.

Building a Door

After the third or fourth layer or after the igloo is complete, the door can be dug.

We like to dig the top of the door at the same level as or a little lower than the bed level. If you are in -70 F, you may want to have the top of the door level with the floor or trench that is 18 inches lower than the bed area. At the most, the top of the door should reach only about three inches above floor level.

We like the door a little wider than our shoulders so we don't brush the snow and get wet going in and out. We also like to make the door tall enough to walk through if you are stooped over. This makes it easier to get in and out.

We dig into the igloo at this level/depth until there is an area big enough to stand up in on the inside. From here we dig an 18-inch deep trough straight across the igloo. We stop short of the other side so that a person can sleep crossways to the trough. (See Diagram B)

Do not dig this trench too early in the construction of your igloo. The Form Handler may stumble in the hole accidentally.

You can also cut a door out of the wall, above ground. Cutting a door in the wall may cause it to sag over time.

An entry tunnel or stabilizing walls will brace the wall and stop this sagging. This is not a problem for a short stay. Try to place the door someplace other than directly on your ramp, preferably in the shade. This will help minimize sagging.

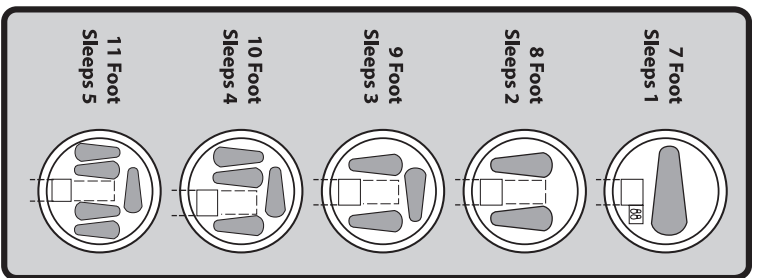
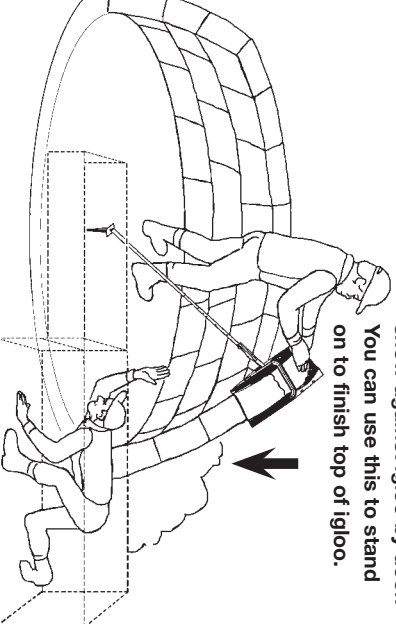

Diagram B

When digging door, pile snow against igloo by door. You can use this to stand on to finish top of igloo.



Correct walkway depth will enable you to stoop over and walk in. use your shoulder width for correct width.

The door on the seven foot igloo is dug into the igloo at full depth until reaching the sleeping pad of the solo winter camper who would sleep perpendicular to the door. Then a shallow trench is dug sideways along the sleeping pad leaving a little shelf next to the door and along the wall.

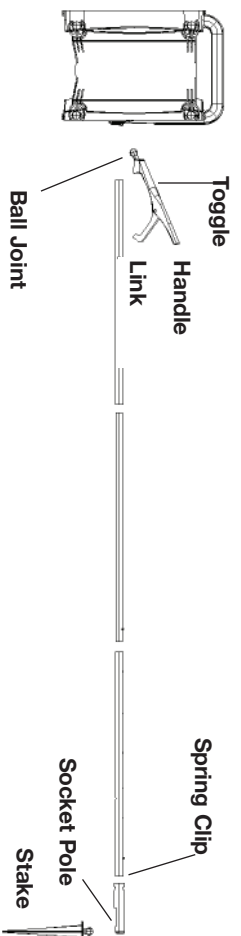
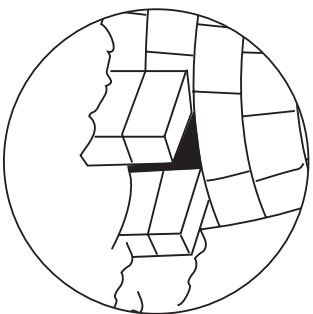

• Insert the center, smaller segment into the opposite end of the pole. Slide it into the larger segment until the spring clip slips into the hole marked "1". Insert the remaining large pole and snap into the first hole marked "8". The 7 ft. igloo is slightly different: the 7 ft. pole goes into the socket pole and the 10 ft. pole goes on the toggle end. The pole spring clip goes into the #2 hole marked "7".

• Diagram A-3 below shows which poles to use according to the size igloo you are building. The 10 ft. pole has a hole marked 7 ft. for that size igloo. The spring clips will lock the poles in place.

• The **Toggle** Assembly consists of the Toggle Link and the Toggle Handle. The socket pole is constructed so that the stake will hang downward on one side only. With the pole horizontal and the stake hanging down, place the toggle on the top side of the assembly by inserting the end of the pole into the pocket in the toggle handle and then pulling out the toggle link and snapping the clips into the holes marked "P".

• Snap toggle ball into Inner Panel.

Note: Put spring clip in first hole of upper pole (except on the 7 foot igloo).

Note: Always adjust this pole to the number of the layer you are building.

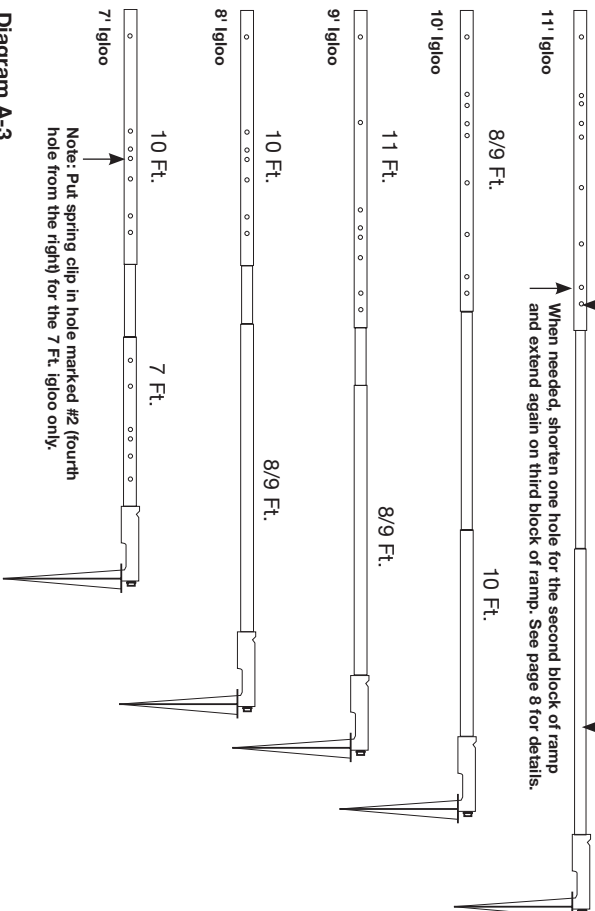

Note: Put spring clip in hole marked #2 (fourth hole from the right) for the 7 Ft. igloo only.

Diagram A-3

Adjusting the pole for each layer

See below for the theory of adjusting the pole for each layer while going through the ramp area. We have used the 8 ft. igloo as an example.

When building the igloo, the pole length adjustments are made on the lower pole (the 8 or 9 ft. pole, see below), these are the numbers you can read because they are on the top of the pole assembly and they are visible. The numbers on the upper pole (10 ft. pole, see below) are on the bottom of the pole assembly and not visible.

The numbered holes, adjusted on the lower pole, correlate to the layer being built. For example, hole 1 is for the first layer, hole #2 is for the second layer, and so forth. In the three block ramp, there needs to be an in-between adjustment between the first layer and the second layer. Adjust the pole length when directly on top of the center block of the ramp. When adjusting the length, go from hole 1 to hole 3 for the center block of the ramp and then go to hole number 2 on the next block when you reach the third block of the ramp, the second layer. When going from layer 2 to layer 3, the adjustment isn't a very big adjustment so just make the adjustment on the center block of the ramp.

From 3 to 4 is a bigger adjustment so stop in hole 1 for the center block of the ramp and then adjust the pole to 4 when you are on the last block of the ramp.

From 4 to 5 there is a large difference from one hole to the next. Here use the hole labeled "R" for ramp. Use this hole on the middle block of the ramp for one block then go to the hole for the actual layer you are on.

Basically, there needs to be an in-between adjustment for the center block of the ramp using the hole labeled "R" for ramp, shortening the top pole or even leaving the toggle handle un toggled can achieve a position or length of pole that works for the centerblock of the ramp.

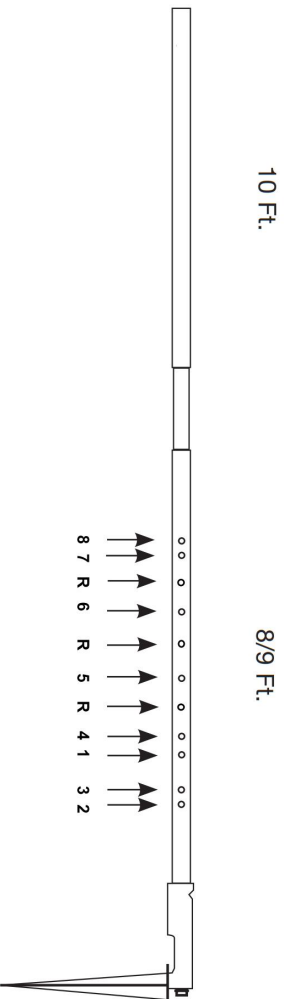

Types of Snow

Sugar/TG snow is old snow. It has fallen early in the fall and has been heated from the sun or from the heat of the ground below. The fingers of the snowflakes don't exist in this type of snow, like a tiny ice-cube. This can also happen when the snow is freezing rain and it is frozen before it lands. The drifting snow of the prairies and high altitudes can also be rolled enough that they become tiny little beads of ice. These beads of ice can become fairly large. We have built in these conditions when the ice crystals were about 1/16 to 1/8 inch diameter. It is hard to be gentle enough to build with this snow but it can be done. Packing gently is the key.

This sugar snow is very difficult to use but it makes the strongest igloo once it freezes. These igloos will last until spring if built correctly on a good foundation. If the snow runs through any cracks try throwing in snow chunks to plug them or hold your arm against the crack to stop it.

Powder snow still has fingers on the snowflakes. These fingers and facets help lock the snow together so handling the form is not so critical. Igloos made of powder can last until spring if built correctly and the snow is gathered with the sweeping technique covered below. Powder layers are sometimes thin and laid over a layer of sugar snow. When these two layers are mixed together, the mixture is a little harder to use than the powder alone, depending on the mix ratio.

After the coldest parts of winter the snow will begin to be warmer and pack easier. You can throw the snow into the form as hard as you want and it will not break the block. The floor is also harder and the stake will not move. This is the easiest type of snow to build with. If the spring slush freezes and you break it up and use it, it will be sugar snow. More ice layers will be present and you will sometimes encounter surface slush with frozen powder below. If you can, build in some shade where the slush layer isn't present. Very cold snow that has been melted by the sun can freeze to the form. Try to mix the slush with the cold layer so it freezes before you put it into the form.

Sweeping the snow

Keep the area you are gathering snow from smooth by sweeping the snow. The sweeping action keeps the area smooth and easy to work with. If you dig the snow out, the area will be choppy and rough.

Sweep off a layer of snow over to the spot where it will be picked up and put into the form. The snow crystals heat up through the friction created in the moving snow. The snow is consolidated when the air is removed like this. This is helpful when you are building with sugar snow. We have found that it is best if the snow is placed in the form within 15 seconds after gathering. If your blocks are still breaking, work the snow more and be careful not to jar the form in any way while building the block.

If you encounter a layer of ice, sweep the snow off in this fashion and then sweat it. The ice cubes that are created like this can be swept up along with some of the snow layer below.

Some spring slush packs too easily and any handling of the snow will turn it into a chunk. In these heavy spring slush conditions, you are better off digging the snow, and the packer can break it up as he packs it.



the entire block. Once you are on the seventh layer, the form is tipped enough that all the snow can be reached from the inside.

After the sixth layer, the Shovelers may not be able to reach high enough to do any packing. You will find that once again the inside packer can pack the entire block. It is very important to place the snow with care. Usually the sliding of the shovel up the wall and rotating it to dump the snow works best.

The last block needs to be packed from the outside. The Inside Panel is used like a cork and there is no longer access from the inside. The Shoveler can stand on the pile of snow created when the door is dug. Or lean snowshoes against the igloo and climb up. (See below) He can also use a ski pole to do the packing.

When using a ski pole push the snow across to the other side of the igloo and pack snow to snow, not to form, again. Keep walking around the igloo packing from all sides until the hole closes up. Check for airholes. If this area is not packed well enough to close all air holes, you will have problems with them opening up when the igloo warms up.



Constructing the Igloo

With your floor level and hard enough to walk on (without sinking in and losing your balance) push in the stake of the assembled ICEBOX. Leave the flange of the stake

1/4-inch from the floor. This way, the stake will not come loose from working its way up and down. **If the snow is too soft, pour a little water on the stake.**

You can now walk the ICEBOX around and check to see if the ledge is the same size on the outside of the form. You can decide where to place the igloo at this time. If you are too close to a rock or tree you won't be able to release the form.

Caution: Do not jar the stake. Any movement will distort the catenary dome design.

Building the Ramp and First Layer

The Form Handler kneels, straddling the pole. Make sure the form, as seen from above, lies at a right angle to the pole. The

Form Handler then tips the ICEBOX towards him so that the line marked "square to floor" is perpendicular to the floor. (See above picture.) Choose the "square to floor" line that corresponds to the size igloo you are building. One of the Shovelers should stand where he can let the Form Handler know when he has tilted it into the proper position. Or you can attach a weighted line to the two holes at the top of the square to floor line which can also help you position the form.

Note: The "square to floor" line is used for this first layer only. See above picture. For the next levels you will center the form on the block below.

With the toggle closed and the U Bar pushed in, the Shoveler dumps powder, with minimal chunks, into the corner formed by the two Outer Panels and the End

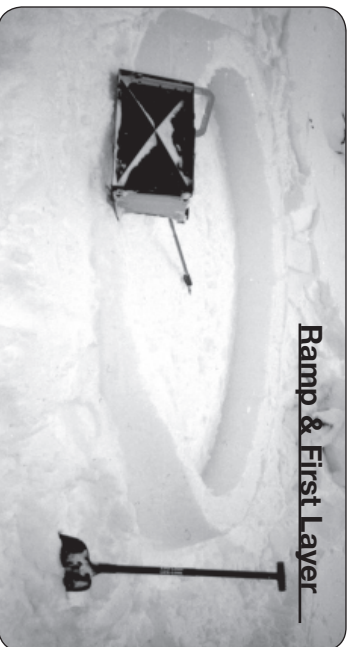

Ramp & First Layer

Panel. With each

shovelful, the Form Handler packs the snow GENTLY with the palm of his hand. Packing too roughly will fracture the block. (Refer to packing detail on page 20.) When you have filled the form to one-third of its height,

Tips

- ✓ Always fill the form evenly and parallel to the edges of the form, not the ground. And make sure edges are crisp and square, not rounded. This will help to keep snow from falling out when you do the next layer.
- ✓ Keep an open dialogue between Shovelers and the Form Handler. When you get to the higher layers, it's important to let each other know what is happening on the other side.
- ✓ Throughout the fifth layer, we recommend leaving a 45° bevel when packing the top leading edge of the block you are building. See picture below.

Subsequent Layers

As the layers get higher, they also tilt inward. By the sixth layer (for all sizes except 7 ft.), you will find it easier to remove the Outer Panel of the ICEBOX. The Shovelers won't have to reach quite as high and will help to pack the snow. The packing and holding techniques also change after the U bar and Outer Panel are removed. The Form Handler will now need to put support on the lower right corner of the Inner Panel. You may also find that it is easier for the Shoveler to pack the snow for the lower half of the block.

The Shoveler will need to keep building at an angle from the wall to the previous block just as the Form Handler has been doing. With the first shovel of snow, the Shoveler will need to pack the lower corner and build out from this. He must remember to keep the wall at full thickness. As it is hard for him to see how thick the wall is, some advice from the Form Handler is needed.

The underlying theory here is, pack snow to snow, not snow to form. You will also notice that it is not necessary to fill the block all the way to the top of the end piece. (See Below) When you move the form and reposition it, there may be a

chunk sticking out. Just break it up and repack. Otherwise there will be air gaps that will undermine the packing support or extra weight when you release the pole that will cause block fractures.

If you work together on the sixth layer, the Shoveler can pack the lower half and then the Form Handler can pack the upper part of the block. Teamwork comes in when the Outside/Shoveler times his placements when you are ready and supporting the form. Then the Form Handler can support the form in the right places while he also packs the snow.

We use the Outside Panel until we are onto the sixth layer. The sixth layer is the only one that the Form Handler can't pack

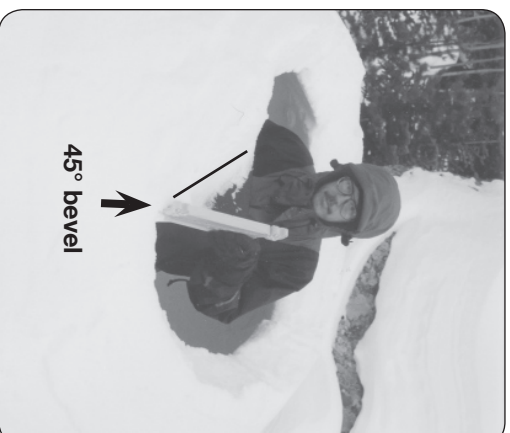



To remove the Outer Panel, peel back as if opening a book.

You can move the form immediately after completing the block.



Tips

- ✓ When packing the form, stay approximately 1-2 inches from the top of the form for the 8 and 9-foot igloo. Fill to the top for the 7, 10 and 11-foot igloos.
- ✓ Position the form so that it overlaps the previous block for two inches or more. This gives support and prevents the edges of the previous block from breaking.

“The stake comes loose”

In general, the handling and operation of the ICEBOX must be smooth, gentle and well thought out. Pull back on the form when moving it to keep the weight on the stake, do not lift the form. As mentioned earlier, if the snow is too soft, pour a little water around the stake. If the socket pole and stake assembly are coming apart when you are building, you are being too rough in handling the form. If the pole is bumped or jarred in any way, your block will break and you will not be able to complete your igloo in sugar snow conditions. Again, when you remove the form, take care to keep the weight on the pole, not lifting it, so that the stake remains firmly in the snow.

The stake and socket pole can also come apart when you are getting up to the higher layers when the pole/toggle handle does not stay vertical to the form. This will effectively pry or pop the stake out of the socket pole as you go around the igloo. To deal with this, you can twist the pole to keep the toggle handle facing up as you build. If the socket pole comes off the stake, it is best to pull the stake and reassemble. Do not pop the assembly back together while the stake is in the

Ramp

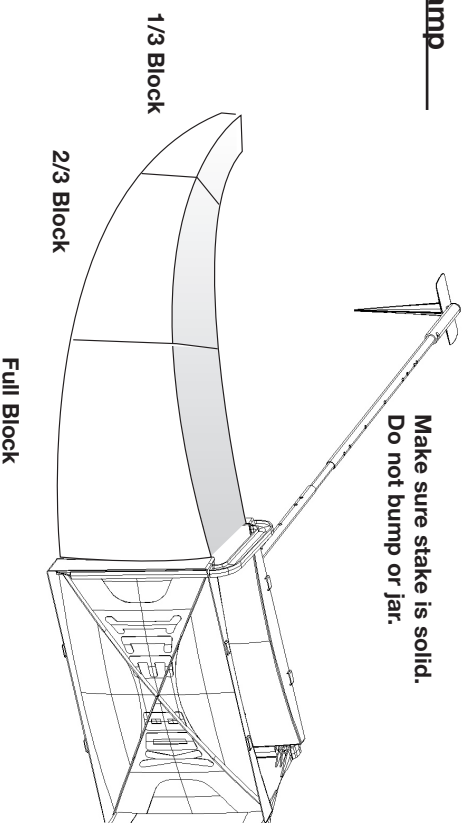

release the U Bar and the toggle. Move form while holding it down to the floor and sliding it left. Watch that the toggle handle doesn't reset itself. Tipping the form inward will help to keep the toggle steady.

Reset the U Bar and the toggle. Now move the ICEBOX into position, overlapping the first block on your ramp. On this block, the first shovelful should be thrown against the end of the first block. The existing block becomes a support for the next block. Pack the ICEBOX until it fills two-thirds of the closed end. Repeat the process until the third block of the incline forms a completed end wall for the first full block of the first layer. (See above) From this point, no partial blocks will be required because the end of each fully formed block will serve as the fourth side of the form to contain the next block.

Resetting the Form
You can position form at a diagonal to reset U Bar and toggle.





Get Into Position

The person gathering the snow should place the snow on the ledge just below the form. It is best that just enough snow be gathered for each block. The snow you leave, expecting to use it later, will be set up and hard when you get back to the snow pile to use it.

The person putting the snow into the form should be standing on the ledge about 2 or 3 feet ahead of the form. You should be able to pick up the snow and put it into the form without stepping or moving. When the outside of the form is still on, this is the position that works best. The snow can be thrown into the form and impacted into the rear wall of snow and not far the form.



When the outside form is taken off, the method changes. The person rounding up the snow should now place the snow for the person that is going to pack the sixth layer from the outside. The shoveler should stand behind the form and along the wall the same distance of two or three feet.



Layers Two through Five

At the center of the second ramp block change your pole length, on the pole attached to the socket pole, to either the next higher numbered hole or the "R" hole (when provided) half way between the numbered holes. Mark this location by placing a ski pole or use a natural marker like a tree. Change the pole length at this exact point on each layer, even if you need to build a half block previous to it, to make the spacing work out right.

We sometimes shorten the upper pole by moving the pin from the end hole to the second hole for one block. This makes the change a bit more gradual. (See page 8 for more detail) When changing the pole length, it helps to have the outside man hold the form while the inside man changes the setting on the pole. It is best if the form is held up in the air and not sitting on the wall of the igloo. It helps the pole slide easier and doesn't jar the stake and loosen it.

After each layer, scrape up any excess snow that falls on the original floor of the igloo. This will ensure that the floor stays level and smooth for sleeping.

Always work the snow by scraping it and patting it down with the shovel. This helps to create denser snow for the igloo and will help it to set up quicker. In extreme cold conditions you may need to actually walk on your pile before putting it into the form to make it bond better.

Note: The seven foot igloo only takes five courses to build and the Outer Panel can be removed on the last two courses. Depending on snow conditions, the Outer Panel can also be removed on the third course. See page 22 for more details.

WARNING: Do not dig further into the base of the igloo than absolutely necessary, when digging a door. The Form Handler will not stumble in the hole accidentally if it is only dug out enough to allow him to exit. Later you will dig a longer trough.